

Dlouhé díly v 9 různých velikostech po 10 cm

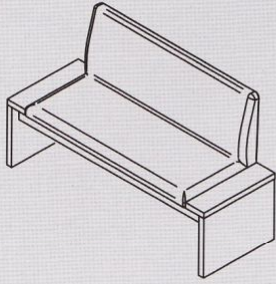

Rohové lavice v 81 různých velikostech po 10 cm

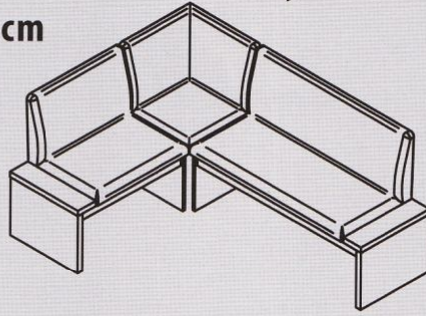

5 rohových dílů (57 x 57 cm)

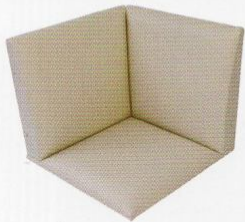

I. čalouněný rohový díl bez prošití

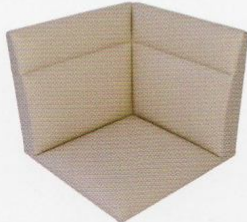

II. čalouněný rohový díl s vodorovným prošitím

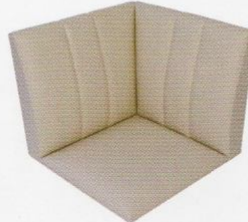

III. čalouněný rohový díl se svislým prošitím



IV. rohový díl s čalouněným sedákem a polštářem



V. rohový díl s políčkou

3 typy čalounění



čalounění opěry E (bez prošití)



čalounění opěry B (s vodorovným prošitím)



čalounění opěry F (se svislým prošitím)

5 typů židlí



Petra



Judita



Laura bez područek



Laura s područkami



Paula

3 typy stolů



Hektor pevný 70 x 110 cm (+40cm)
80 x 120 cm (+40cm)
85 x 130 cm (+40cm)



Helena pevný 70 x 110 cm (+40cm)
80 x 120 cm (+40cm)
85 x 130 cm (+40cm)

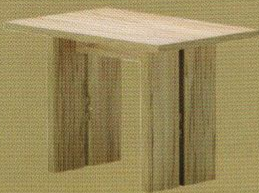

Paris pevný 70 x 110 cm (+40cm)
80 x 120 cm (+40cm)
85 x 130 cm (+40cm)

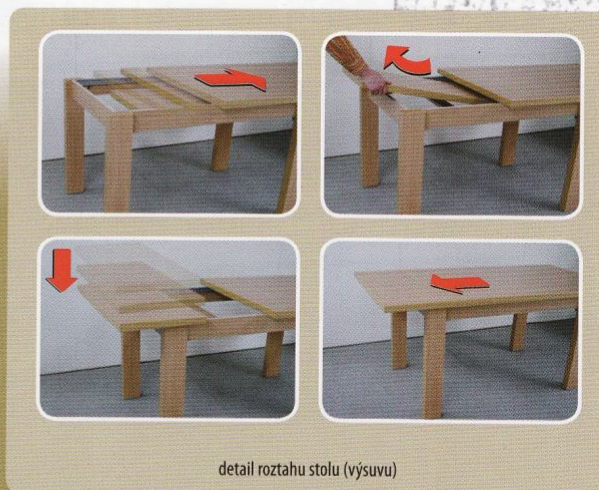

detail roztahu stolu (výsuvu)

7 dekorů dřevěných částí



buk



jádrový buk



divoký dub



světlý ořech



tmavý ořech



švestka



bílá